

Portable laser measurement and calibration



Machine tools and CMM

The ultimate tool for machine tool and CMM verification to international standards



Motion systems

Unique dynamic performance for high speed, high resolution investigations



Research and metrology

Traceable measurement for calibration and research laboratories



From the world's leading laser measurement system manufacturer: the XL-80 laser system

Renishaw has been designing, manufacturing and supplying laser interferometer systems for over 20 years. Its ML10 laser system has become a globally recognised standard for accuracy and reliability in use.

The new XL-80 laser system offers greatly increased portability, system accuracy and improved dynamic measurement performance. It is quicker and easier to use, whilst retaining the benefits of a pure interferometry based system; a proven technology that has made Renishaw laser systems the preferred choice of companies worldwide.

XL-80 retains Renishaw's key virtues of accuracy, reliability and durability in day-to-day use, where it really matters.



Increased performance from the XL laser measurement system widens your measurement options. Significantly smaller than existing systems, it delivers improved portability and ease of use, helping your business to stay ahead

XL-80 laser (with optional universal shutter) and XC-80 compensator

XL system components

The basis of the new system is a compact laser head (XL-80) and an independent compensator system (XC-80)

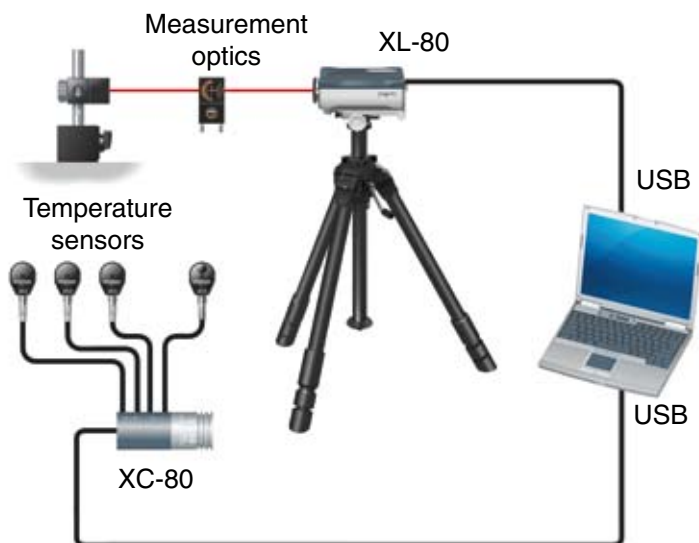

XL-80 laser

The XL-80 laser produces an extremely stable laser beam with a wavelength that is traceable back to national and international standards.

The laser frequency stability is specified as ± 0.05 ppm over 1 year and ± 0.02 ppm over 1 hour. This excellent performance is achieved by dynamic thermal control of the laser tube length to within a few nanometres.

Linear measurement accuracy is an assured ± 0.5 ppm over the whole environmental range i.e. from $0\text{ }^{\circ}\text{C}$ - $40\text{ }^{\circ}\text{C}$ ($32\text{ }^{\circ}\text{F}$ - $104\text{ }^{\circ}\text{F}$) and 650 mbar - 1150 mbar. Readings are taken at 50 kHz, with a maximum linear measurement speed of 4 m/s and a linear resolution of 1 nm; even at maximum speed.

As the XL system uses interferometry as the basis for all its measurement options (not just linear), you can have confidence in the accuracy of all your measurements.

With integrated USB there is no requirement for a separate laser-to-PC interface. The laser also features an auxiliary analogue signal output as standard, with quadrature output a factory option. The same socket also accepts a trigger signal input for data capture synchronisation.

LED status lights, indicating laser status and signal strength, provide back-up to the software's 'on-screen' indicators. Together with a switchable long range mode (40 m - 80 m) and a warm-up time of less than 6 minutes, these features make the XL-80 quick and easy to use.

An external, switch mode power supply ensures 90 V - 264 V flexibility in input voltage.

XL-80 system components

XC-80 compensator and sensors

The XC-80 compensator is a key factor in your XL system's measurement accuracy. Featuring 'intelligent sensors' that process the readings at source, the compensator very accurately measures air temperature, air pressure and relative humidity.

Sensor cables are 5 m long and detachable for easy replacement. Multiple cables can be screwed together for extended lengths on longer machines.



The design of the XC-80 and sensors ensures extremely accurate readings over the full range of operating conditions, from units that are built to withstand the daily handling that most systems will receive.

Up to three material temperature sensors can also be attached to the XC-80 compensator to allow linear measurements to be normalised to a standard material temperature of 20 °C.

Both the air and material temperature sensors are 'intelligent'. Integral microprocessors analyse and process the sensors' output before sending digital temperature values to the XC-80 compensator. This offers more secure measurements and is a key reason why the XC-80 is so compact.

It then modifies the nominal value of the laser wavelength to give a true value, used in displacement calculations, which virtually eliminates any measurement errors resulting from these variations. This can be done automatically, every 7 seconds, as indicated by LED status lights on the XC-80 unit.

The XC-80 weighs only 490 g and together with the XL-80 weighs just over 3 kg (including connecting cables, XL power supply and sensors).

Like the XL-80 laser, the compensator is directly connected to your PC via a USB port which, for the XC unit, also supplies power (no separate power supply is required).

Sensor performance	Range	Accuracy
Material temperature	0 °C - 55 °C	±0.1 °C
Air temperature	0 °C - 40 °C	±0.2 °C
Air pressure	650 mbar - 1150 mbar	±1 mbar
Relative humidity (%)	0% - 95% non-condensing	±6% RH

XL system components

Tripod and stage

Unless you are using a dedicated measurement rig, then you are likely to need a tripod and stage to adjust the laser's position relative to the desired measurement axis. A new universal tripod has been extensively tested to provide a stable adjustable base in a compact, lightweight unit.

The XL tripod stage allows for precise angular rotation and translation of the XL-80 and is designed to be left attached to the laser unit for easy storage and quick set-up.



A 'quick fit/release' mechanism enables rapid and secure fixing to the tripod. For those applications where tripod mounting is not convenient, e.g. for mounting directly on a machine tool table, the stage and laser can also be mounted on most standard magnetic bases, using an optional adapter with M8 thread.

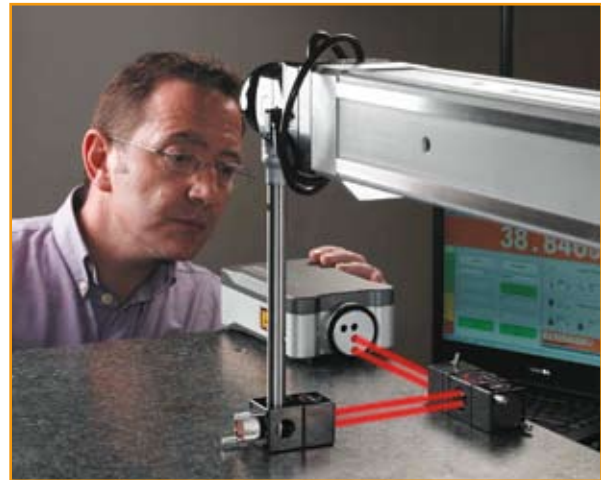

Due to careful design, the XL-80 laser and optics can also be placed directly on a granite table (without tripod stage) for co-ordinate measuring machine (CMM) calibration.

The tripod and tripod case together weigh just 6.2 kg, to complement the portability of the rest of the laser system.



LaserXL™ software maximises your XL system performance and flexibility

Powerful software and clear but extensive support documentation are key to releasing the potential of the XL-80 system



LaserXL™ software

LaserXL™ software includes modules for linear, angular, rotary axis, flatness, straightness and squareness measurements, as well as dynamic measurement capability (see below). Users can select from English or a choice of several main languages* for LaserXL™, QuickViewXL™ and system manual.

Standard report options conform to many international machine performance checking standards, such as ISO, ASME, VDI, JIS and GB, and include a comprehensive Renishaw analysis.

The standard analysis software includes an option to generate compensation values for use in the CNC machine's controller, significantly improving the machine's positioning accuracy. Optional 'stand alone' linear error compensation packages include additional capability to read and write to the machine's controller, enabling existing error compensation parameters to be read and new ones to be uploaded.

Dynamic measurement

LaserXL™ dynamic measurement facility allows the collection of data at rates of 10 Hz to 50 kHz (at 12 preset values) and provides displacement, velocity and acceleration data. There's even an integrated FFT package for frequency analysis.

For real-time 'oscilloscope style' display of live position velocity or acceleration data refer to QuickView™ software.

These dynamic measurements allow certain machine error characteristics to be highlighted and quantified. For example:

- Pre-load and hysteresis of ballscrew and nut mechanisms
- Positional stability and encoder performance
- Resonance characterisation of drive motors, spindles and other systems
- Feedrate accuracy, stability and interpolation accuracy
- Control-loop optimisation

Dual axis measurement

In some installations, one axis is controlled by two drives and two feedback systems (eg Spar mills, lathes and large dual beam type CMMs). In this instance, a second laser and optics, coupled with dual axis software, provides the capability to automatically capture data of parallel axes simultaneously.

Dual axis measurement software is included as standard with XL™ software.

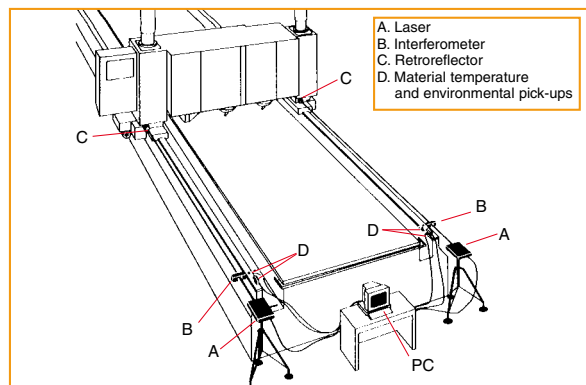

Typical dual axis set-up

* Software is supplied on CD in the following languages: English, German, French, Italian, Spanish, Japanese, Chinese, Taiwanese, Russian and Korean.

QuickViewXL™ software for live dynamic analysis

Live, real-time display of laser measurement data for linear displacement, velocity and acceleration analysis

QuickViewXL™ is a simple to use, intuitive software package to capture, review and save dynamic data acquired via the XL-80 laser measurement system.

Knowledge of a position sensitive machine's dynamic characteristics - acceleration, velocity, vibration, settle time, resonance and damping - is critical in many applications. These characteristics will influence operational capabilities such as positional accuracy, repeatability, surface finish, throughput and wear.

QuickViewXL™ provides the ideal tool for R&D, as it enables quick and easy investigation, review and characterisation of motion systems. It provides users with the following functionality:

- Live data display in an oscilloscope style format
- Data capture rate of 50 kHz
- Supports measurement with linear, angular or straightness measurement optics
- Three modes of data capture: free running, single shot trigger and multi-shot trigger



X-Y stage (photo courtesy of Danaher Precision Systems)

QuickViewXL™ software



- Distance, velocity and acceleration display modes
- Selectable filters of 1, 2, 5, 10, 20, 50 and 100 ms response
- Cursors for measurement of amplitude, time and frequency
- Manual scale, pan and zoom functions allowing 'close up' analysis of selected data
- Auto scale option

Captured data can easily be loaded into supporting applications such as MathCAD, Mathematica and Excel for further analysis using CSV file format. It can also be loaded into Renishaw's LaserXL™ software allowing FFT analysis.

PC minimum requirements (Laser XL™ and QuickViewXL™)

Correct PC specification is vital for system performance. Please check with Renishaw for latest details.

- Processor - 1 GHz Pentium, 512 MB RAM
- Drives - CD-ROM for software installation
- Minimum screen resolution 1024 x 768, SVGA
- Hard Disk - 100 MB drive space needed for software installation
- Peripherals - Keyboard and Microsoft mouse or compatible pointing device
- Operating system - Windows® XP SP2/SP3, Windows Vista™ or Windows® 7 (32 and 64 bit versions of these operating systems supported)
- Interface - Recommended 3 free USB, 2 ports for XL laser, XC compensator and USB mouse. More USB ports may be required if an RX10, error compensation or dual functionality is required. Note: a USB hub can be used to increase the number of available USB ports.

System performance

Without reliable and accurate wavelength compensation errors of 20 ppm - 30 ppm would be common



- ±0.5 ppm** certified linear measurement accuracy over the full range of environmental operating conditions
- 1 nm** linear resolution (even at max. velocity)
- 4 m/s** maximum travel velocity
- 7 seconds** between each automatically updated environmental compensation
- 50 kHz** dynamic capture rate
- 80 m** linear range as standard

The greatest uncertainty in most laser measurements arises from variations in environmental conditions (air temperature, air pressure, humidity) compared to nominal values. Even small variations in conditions will alter the laser wavelength and the resulting measurement reading. For example, the following changes will increase laser wavelength by 0.25 ppm (parts per million):

- 0.26° C air temperature increase
- 0.93 mbar air pressure decrease

When variations of temperature, humidity and pressure from nominal values are combined they can cause 20-30 ppm uncertainty in measurement (even if the test conditions remain stable).

Renishaw uses its XC-80 environmental compensation unit and very accurate environmental sensors to compensate for the effects on the laser wavelength.

Great effort has been taken to ensure Renishaw's XC-80 compensation system and sensors are accurate across the entire operating range of the system. It is this that maintains ±0.5 ppm linear measurement accuracy from 0 °C - 40 °C (32°F - 104 °F) and over the full air pressure range (see graph comparisons with competitor system).

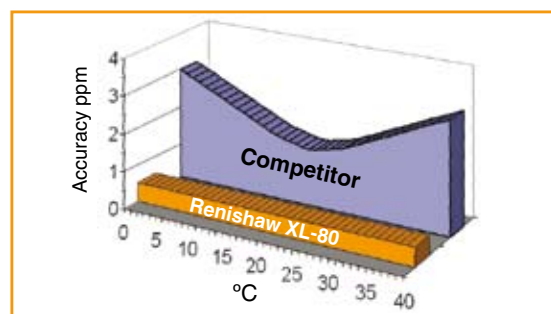

System linear measurement accuracy vs. environmental temperature

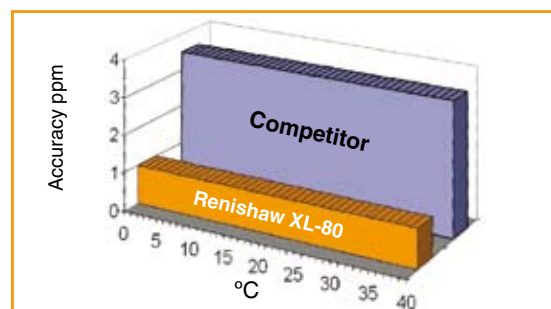

Material normalisation accuracy @ 10 ppm/°C

System benefits

Other factors for accuracy

- **Laser frequency stabilisation** – ± 0.05 ppm over 1 year, ± 0.02 ppm over 1 hr is achieved by thermal control of the laser tubes length to within nanometres.
- **Separate interferometer** – Renishaw uses a remote interferometer rather than one mounted on or inside the laser head, to avoid thermal drift.
- **Accuracy for all measurements** - Laser linear measurement accuracy is only part of the metrology solution. You can also capture and analyse linear, angular, straightness, squareness, flatness and rotary axis motion with your XL-80 system, all using traceable linear measurement as a basis.

Measurement normalisation

To compensate for a machine's thermal expansion, the XC-80 unit can also receive data from up to three material temperature sensors. Placed in appropriate positions on the machine under test these normalise all readings to a reference temperature of 20 °C (68 °F). Thermal compensation is particularly important when performing linear measurements, especially on large machines or machines made of high expansion materials.

Accuracy by design

We believe that you should understand the background to our performance claims, to give you the confidence that the XL-80 delivers real accuracy where it counts, in day to day use.

Renishaw's accuracy specification is derived in accordance with recognised procedures for the calculation of measurement uncertainty (EA - 4/02) for laser stability, sensor output, and all key parameters and calculations affecting the final measurement. A summary of the error budget that is the basis of the published specification is available.

Overall system accuracy is quoted to the internationally recognised 95% confidence level ($k=2$) and includes allowance for drift in service.

Proven field performance

With an installed base of thousands of units worldwide operating over 18 years, our track record shows that Renishaw's laser systems continue to meet specifications day-in day-out, under a wide variety of conditions. This level of performance has been repeatedly verified by third party testing (including national laboratories).

Ease of use and set-up

Easy to transport, quick to set-up and use, the XL-80 allows users to reduce waiting time and increase available measurement time.

- Short preheat time (below six minutes)
- Laser and stage designed for combined storage
- Stage features quick release tripod mounting



- Reduced components and connections. Both laser and compensator connect to your PC via USB; no separate interface, and no complicated set-ups are required
- The XC-80 compensator is powered via its USB connection, so no external power supply is needed

Flexibility and ease of operation

- 'Switchable' between standard (40 m) and long (80 m) range modes
- An analogue I/O port allows for analogue and quadrature signal outputs (factory specified option) and a trigger signal input
- Easy to read LEDs for status and signal strength indication
- Uses standard or cordless mouse as trigger for remote manual data capture

The small size of the XL-80 laser and XC-80 compensator means that the whole system (less tripod) can now be packed into a truly portable 'wheelie-case'. A complete linear system in its case weighs around 12 kg. Even with the optional angular optics and accessories it weighs just over 15 kg; a highly portable system that others just can't match.



System 'wheelie-case' and additional tripod case are truly portable



Base system case takes full linear and angular system*

* Optional larger case available for comprehensive optics and accessories storage

Total confidence

Quality in design, build and technical support are Renishaw hallmarks. That's vital, whether you're dealing in microinches or nanometres

Design



The XL system design is based on extensive feedback from laser and non-laser users to design out current system limitations and design in expected future requirements. The XL-80 is designed to allow updates and developments as user requirements change in the future.

The performance of Renishaw laser systems has been independently verified by the National Physical Laboratory (NPL), UK and Physikalisch-Technische Bundesanstalt (PTB), Germany.



Build

Renishaw's extensive manufacturing capabilities allow it to produce nearly all components and assemblies in its own factories.

It has an extensive and modern machine shop including surface finishing. There's even a complete PCB design, build and test facility.

This in-house manufacture, together with design, gives Renishaw the capability to fully understand and control the design and build process, unlike suppliers who outsource these activities.



Total confidence

Quality in depth

Renishaw plc is certified and audited regularly to ISO 9001:2008, the most recent ISO QA systems standard. This covers all aspects of design, manufacture, sales and after sales support, including our recalibration facilities.

The certificate is issued by BSI Management Systems, an internationally recognised certification body, accredited by UKAS.



ISO9001:2008 quality certificate

as well as full details of calibration standards used and of traceability to international standards.

Separate laser and sensor certification allows you to interchange components whilst maintaining traceable accuracy.

Product recalibration is available through your local Renishaw contact at facilities in the UK and USA (with NPL traceability), and Germany (with PTB traceability).





Laser calibration

Test and certification

Product calibration of all laser systems is carried out by Renishaw and is traceable to the NPL (National Physical Laboratory) in the UK, using Renishaw's own certified iodine stabilised laser calibration system. Comprehensive calibration certificates are issued with all XL-80, XC-80 and RX10 systems giving test data in both tabular and graphical format,

XL-80 laser system: main specifications

Laser head XL-80	
Dimensions (weight)	214 mm x 120 mm x 70 mm (1.85 kg)
Power supply	External, 90 V AC - 264 V AC, auto sensing
System measurement capability	Linear, angular (and rotary), flatness, straightness and squareness
Laser output	
Interface	Integral USB comms, no separate interface
TPin (trigger signal)	Yes
Quadrature signal output	Yes (factory option)
Analogue voltage output	Yes
Signal strength LEDs	Yes

Environmental compensator XC-80	
Dimensions (weight)	135 mm x 58 mm x 52 mm (490 g)
Power supply	Powered via USB from PC
Internal sensors	Air pressure Relative humidity
Remote sensors	1 air temperature 1 - 3 material temperature
Interface	Integral USB comms, no separate interface

Your XC compensator is supplied as a kit including:

- XC compensator unit
- Air temperature sensors kit
- Material temperature sensor kit
- USB cable
- System manual (CD-ROM)

Your XL laser is supplied as a kit including:

- XL laser unit (with standard shutter)
- USB cable
- Power supply and cables
- Aux I/O connector
- System manual (CD-ROM)

System performance		
Linear measurement range	80 m	
Linear measurement accuracy	±0.5 ppm	
Laser frequency accuracy	±0.05 ppm	
Resolution	1 nm	
Maximum travel velocity	4 m/s*	
Dynamic capture rate	10 Hz - 50 kHz**	
Preheat time	<6 minutes	
Specified accuracy range	0 °C - 40 °C	
Environmental sensors		
	Range	Accuracy
Material temperature	0 °C - 55 °C	±0.1 °C
Air temperature	0 °C - 40 °C	±0.2 °C
Air pressure	650 mbar - 1150 mbar	±1 mbar
Relative humidity (%)	0% - 95% non-condensing	±6% RH
* 1.6 m/s (80 nm quadrature); 0.2 m/s (10 nm quadrature)		
** 20 MHz in quadrature mode		

System cases and tripod		
	Case 1 (base system)	Case 2 (full system)
Case dimensions (L x H x D)	560 mm x 351 mm x 229 mm	560 mm x 455 mm x 265 mm
System weight*	12 kg - 17 kg	16 kg - 25 kg
	Universal tripod base	
Dimensions folded with boss (weight)	Ø160 mm x 640 mm (3.9 kg)	
Working height range (to laser output beam)	Minimum: 540 mm Maximum: 1560 mm (column up)	
Tripod case	Armoured nylon bag**	
Case dimensions	670 mm x 170 mm x 170 mm	
* System in case weight depends upon options specified Lower weights indicated are for: Case 1: Linear XL and XC system Case 2: Linear, angular and straightness XL and XC system		
** Rigid tripod case available as an option		

Other	
Warranty	3 years (with 5 year option)
Certification	XL, XC, air and material temperature sensors. Certificates comply with requirements of ISO 17025.
Quality system	ISO 9001, BSI certified

Measurement optics

The XL-80 system uses the same range of optics as Renishaw's ML10 system, covering linear, angular (including rotary axes), straightness, squareness and flatness measurements. All measurements are interferometric and therefore use the traceable international standard wavelength of laser light.



Other systems which use electronic targets to measure pitch, yaw and straightness errors, often compromise measurement accuracy and stability.



For rotary axis measurements the RX10 rotary axis kit is available. This high precision indexing table, when used with the XL-80 system and angular optics, gives fully automatic calibration of axes, with ± 1 arc sec accuracy.

Optics accessories

LS350 beam steerer

This unique patented optic provides easy angular adjustment of the laser beam in both horizontal and vertical planes, making laser alignment a simple one step process. The beam steerer speeds up linear, angular and straightness measurements, whether in-line or at 90° . The optic is also compatible with the linear/angular combination kit and swivel/fixed turning mirrors. Clamping screws allow the beam steerer to be easily attached to measurement optics.



Specification	Metric	Imperial
Steering angle range	± 35 mm/m	$\pm 2^\circ$
Axial range	0 m – 10 m	0 ft – 33 ft

Swivel mirror

This mirror can be used as an alignment aid for ANSI B5.54 diagonal measurements. It is also useful when measuring slant-bed lathes. Clamping screws allow the mirror to be easily attached to measurement optics.



Fixed turning mirror

This mirror reflects the laser beam through 90° . Like the swivel mirror, it can be attached to the measurement optics to aid optical set-up and is used primarily when there is restricted access to the required axis of measurement.



Measurement specifications

Linear

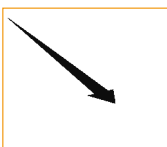

Specification	Metric	Imperial
Linear measurement range	0 m – 80 m	0 in – 3200 in
Measurement accuracy (with XC-80 compensator)	± 0.5 ppm (parts per million)	
Resolution	0.001 μ m	0.1 μ in
For measurements over 40 m it is recommended to use the long range linear accessory kit.		
Performance specifications for linear (above) and other measurement modes are quoted to 95% confidence level ($k = 2$), and are valid across the full environmental operating range.		

Angular



Specification	Metric	Imperial
Axial range	0 m - 15 m	0 in - 590 in
Angular measurement range	± 175 mm/m	$\pm 10^\circ$
Angular accuracy	$\pm 0.2\% \pm 0.5 \pm 0.1M$ μ m/m	$\pm 0.2\% \pm 0.1 \pm 0.007F$ arc sec
Resolution	0.1 μ m/m	0.01 arc sec
Where M = measurement distance in metres; F = measurement distance in feet % = percentage of calculated angle * With high accuracy angular optics ($\pm 0.6\%$ with standard optics)		

Rotary

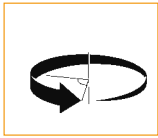

Specification	Metric	Imperial
Angular range	Unlimited	
Indexing accuracy (standard)	± 5 μ m/m	± 1 arc sec
Repeatability	1 μ m/m	0.2 arc sec
Mounting	Top or bottom faces for spindle or table location	
Axis of rotation	Vertical or horizontal	
Control	Automatic via RS232 to PC	
Maximum velocity of indexer table	30 rpm when the measurement step size is less than 10° 2 rpm when measurement step size is more than 10°	

Flatness

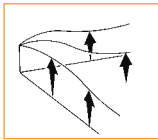

Specification	Metric	Imperial
Axial range	0 m - 15 m	0 in - 590 in
Flatness measurement range	± 1.5 mm	± 0.06 in
Accuracy	$\pm 0.6\% \pm 0.02 M^2$ μ m	$\pm 0.6\% \pm 0.08 F^2$ μ in
Resolution	0.01 μ m	1 μ in
Foot spacing	50 mm, 100 mm and 150 mm	2 in, 4 in and 6 in (approx)
Where M = length of the diagonal in metres; F = length of the diagonal in feet; % = percentage of calculated flatness		

Straightness

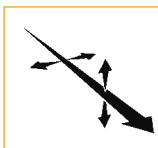

Specification	Metric	Imperial
Axial range (short range)	0.1 m - 4.0 m	4 in - 160 in
(long range)	1 m - 30 m	40 in - 1200 in
Straightness measurement range	± 2.5 mm	± 0.1 in
Accuracy (short range)	$\pm 0.5\% \pm 0.5 \pm 0.15 M^2$ μ m	$\pm 0.5\% \pm 20 \pm 0.5 F^2$ μ in
(long range)‡	$\pm 2.5\% \pm 5 \pm 0.015 M^2$ μ m	$\pm 2.5\% \pm 200 \pm 0.05 F^2$ μ in
Resolution (short range)	0.01 μ m	1 μ in
(long range)	0.1 μ m	10 μ in
Where M = measurement distance in metres; F = measurement distance in feet; % = percentage of displayed value ‡ subject to environmental conditions		

Squareness

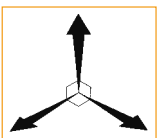

Specification	Metric	Imperial
Range	$\pm 3/M$ mm/m	$\pm 2000/F$ arc sec
Accuracy (short range)	$\pm 0.5\% \pm 2.5 \pm 0.8 M$ μ m/m	$\pm 0.5\% \pm 0.5 \pm 0.05 F$ arc sec
(long range)	$\pm 0.5\% \pm 2.5 \pm 0.08 M$ μ m/m	$\pm 2.5\% \pm 0.5 \pm 0.005 F$ arc sec
Resolution	0.01 μ m/m	0.01 arc sec
Where M = measurement distance in metres of the longest axis; F = measurement distance in feet; % = percentage of displayed value		

About Renishaw

Renishaw is an established world leader in engineering technologies, with a strong history of innovation in product development and manufacturing. Since its formation in 1973, the company has supplied leading-edge products that increase process productivity, improve product quality and deliver cost-effective automation solutions.

A worldwide network of subsidiary companies and distributors provides exceptional service and support for its customers.

Products include:

- **Dental CAD/CAM** scanning and milling systems
- **Encoder systems** for high accuracy linear, angle and rotary position feedback
- **Laser and ballbar systems** for performance measurement and calibration of machines
- **Medical devices** for neurosurgical applications
- **Probe systems and software** for job set-up, tool setting and inspection on CNC machine tools
- **Raman spectroscopy systems** for non-destructive material analysis
- **Sensor systems and software** for measurement on CMMs (co-ordinate measuring machines)
- **Styli** for CMM and machine tool probe applications

Renishaw worldwide

Australia

T +61 3 9521 0922
E australia@renishaw.com

Austria

T +43 2236 379790
E austria@renishaw.com

Brazil

T +55 11 4195 2866
E brazil@renishaw.com

Canada

T +1 905 828 0104
E canada@renishaw.com

The People's Republic of China

T +86 21 6180 6416
E china@renishaw.com

Czech Republic

T +420 548 216 553
E czech@renishaw.com

France

T +33 1 64 61 84 84
E france@renishaw.com

Germany

T +49 7127 9810
E germany@renishaw.com

Hong Kong

T +852 2753 0638
E hongkong@renishaw.com

Hungary

T +36 23 502 183
E hungary@renishaw.com

India

T +91 80 6623 6000
E india@renishaw.com

Israel

T +972 4 953 6595
E israel@renishaw.com

Italy

T +39 011 966 10 52
E italy@renishaw.com

Japan

T +81 3 5366 5316
E japan@renishaw.com

Malaysia

T +60 3 5361 4420
E malaysia@renishaw.com

The Netherlands

T +31 76 543 11 00
E benelux@renishaw.com

Poland

T +48 22 577 11 80
E poland@renishaw.com

Russia

T +7 495 231 16 77
E russia@renishaw.com

Singapore

T +65 6897 5466
E singapore@renishaw.com

Slovenia

T +386 1 527 2100
E mail@rls.si

South Korea

T +82 2 2108 2830
E southkorea@renishaw.com

Spain

T +34 93 663 34 20
E spain@renishaw.com

Sweden

T +46 8 584 90 880
E sweden@renishaw.com

Switzerland

T +41 55 415 50 60
E switzerland@renishaw.com

Taiwan

T +886 4 2473 3177
E taiwan@renishaw.com

Thailand

T +66 2 746 9811
E thailand@renishaw.com

Turkey

T +90 216 380 92 40
E turkiye@renishaw.com

UK (Head Office)

T +44 1453 524524
E uk@renishaw.com

USA

T +1 847 286 9953
E usa@renishaw.com

For all other countries

T +44 1453 524524
E international@renishaw.com